

MINIMUM UNIT ORDER : 1000pcs PER EACH MODELS

LEAD TIME(PRODUCTION BY ORDER) : 2 MONTHS~

| CAL. | | 2015-10A | 2015-10U | 2015-10X | 2015-10Z |
|-------------------|------------|---------------------|---------------------|---------------------|---------------------|
| 6 3/4x8''' | | | | | |
| Dial Drawing | | PDF | PDF | PDF | PDF |
| Date | W.POSITION | 3H | 6H | 3H | 6H |
| | W.SHAPE | SQUARE | SQUARE / ROUND | SQUARE | SQUARE / ROUND |
| Date | BACKGROUND | WHITE | BLACK | BLACK | WHITE |
| | LETTER | BLACK | WHITE | WHITE | BLACK |
| CROWN POSITION | | 3H | 3H | 3H | 3H |
| ORDER | | STANDARD | PRODUCTION BY ORDER | PRODUCTION BY ORDER | STANDARD |

| CAL. | | 2005-00A | 2005-0AD | 2005-0AE | 2005-0AK | 2005-0AN |
|-------------------|----------------|---------------------|---------------------|---------------------|---------------------|---------------------|
| 6 3/4x8''' | | | | | | |
| Dial Drawing | | PDF | PDF | PDF | PDF | PDF |
| Date | W.POSITION | 3H | 3H | 3H | 3H | 3H |
| | W.SHAPE | SQUARE | SQUARE | SQUARE | SQUARE | SQUARE |
| Date | BACKGROUND | WHITE | WHITE | WHITE | WHITE | WHITE |
| | LETTER | BLACK | BLACK | BLACK | BLACK | BLACK |
| DAY | W. POSITION | 3H | 3H | 3H | 3H | 3H |
| | W.SHAPE | STRAIGHT | STRAIGHT | STRAIGHT | STRAIGHT | STRAIGHT |
| DAY | LANGUAGE | ENGLISH / SPANISH | ENGLISH / FRENCH | ENGLISH / GERMAN | ENGLISH / ARABIC | ENGLISH / JAPANESE |
| | BACKGROUND | WHITE | WHITE | WHITE | WHITE | WHITE |
| DAY | LETTER | BLACK | BLACK | BLACK | BLACK | BLACK |
| | CROWN POSITION | 3H | 3H | 3H | 3H | 3H |
| ORDER | | STANDARD | PRODUCTION BY ORDER | PRODUCTION BY ORDER | PRODUCTION BY ORDER | PRODUCTION BY ORDER |

| CAL. | | 2005-0AU | 2005-0TK | 2005-0VK |
|-------------------|----------------|---------------------|---------------------|---------------------|
| 6 3/4x8''' | | | | |
| Dial Drawing | | PDF | PDF | PDF |
| Date | W.POSITION | 3H | 3H | 6H |
| | W.SHAPE | SQUARE | SQUARE | SQUARE |
| Date | BACKGROUND | WHITE | BLACK | WHITE |
| | LETTER | BLACK | WHITE | BLACK |
| DAY | W. POSITION | 3H | 3H | 3H |
| | W.SHAPE | STRAIGHT | STRAIGHT | STRAIGHT |
| DAY | LANGUAGE | ENGLISH / CHINESE | ENGLISH / ARABIC | ENGLISH / ARABIC |
| | BACKGROUND | WHITE | WHITE | WHITE |
| DAY | LETTER | BLACK | BLACK | BLACK |
| | CROWN POSITION | 3H | 3H | 3H |
| ORDER | | STANDARD | PRODUCTION BY ORDER | PRODUCTION BY ORDER |

MINIMUM UNIT ORDER : 1000pcs PER EACH MODELS

LEAD TIME(PRODUCTION BY ORDER) : 2 MONTHS~

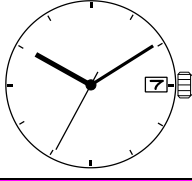
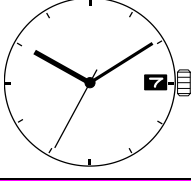
| CAL. | | 2115-20A | 2115-20P |
|----------------|------------|---|---|
| <u>10 1/2"</u> | |  |  |
| Dial Drawing | | PDF | PDF |
| Date | W.POSITION | 3H | 3H |
| | W.SHAPE | SQUARE | SQUARE |
| | BACKGROUND | WHITE | BLACK |
| | LETTER | BLACK | WHITE |
| CROWN POSITION | | 3H | 3H |
| ORDER | | STANDARD | PRODUCTION BY ORDER |

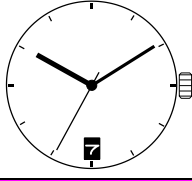
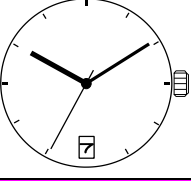

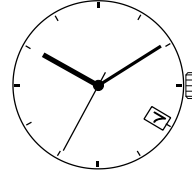
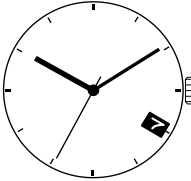
| CAL. | | 2115-20T | 2115-20Z |
|----------------|------------|---|---|
| <u>10 1/2"</u> | |  |  |
| Dial Drawing | | PDF | PDF |
| Date | W.POSITION | 6H | 6H |
| | W.SHAPE | SQUARE / ROUND | SQUARE / ROUND |
| | BACKGROUND | BLACK | WHITE |
| | LETTER | WHITE | BLACK |
| CROWN POSITION | | 3H | 3H |
| ORDER | | PRODUCTION BY ORDER | STANDARD |

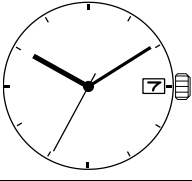
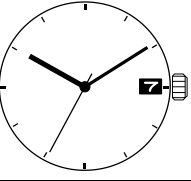
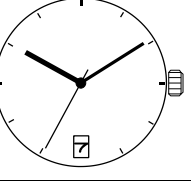
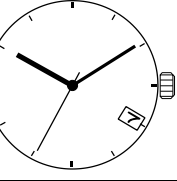
| CAL. | | 2115-2AZ | 2115-2ZY |
|----------------|------------|---|---|
| <u>10 1/2"</u> | |  |  |
| Dial Drawing | | PDF | PDF |
| Date | W.POSITION | 4H (SLA) | 4H (SLA) |
| | W.SHAPE | SQUARE | SQUARE |
| | BACKGROUND | WHITE | BLACK |
| | LETTER | BLACK | WHITE |
| CROWN POSITION | | 3H | 3H |
| ORDER | | PRODUCTION BY ORDER | PRODUCTION BY ORDER |

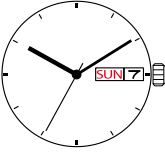
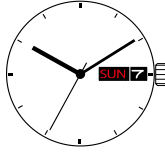

| CAL. | | 2117-20A | 2117-20P | 2117-20Y | 2117-2AZ |
|-----------------------------|------------|---|---|--|---|
| <u>10 1/2"</u> High Hand | |  |  |  |  |
| Dial Drawing | | PDF | PDF | PDF | PDF |
| Date | W.POSITION | 3H | 3H | 6H | 4H (SLA) |
| | W.SHAPE | SQUARE | SQUARE | SQUARE / ROUND | SQUARE |
| | BACKGROUND | WHITE | BLACK | WHITE | WHITE |
| | LETTER | BLACK | WHITE | BLACK | BLACK |
| CROWN POSITION | | 3H | 3H | 3H | 3H |
| ORDER | | PRODUCTION BY ORDER | PRODUCTION BY ORDER | PRODUCTION BY ORDER | PRODUCTION BY ORDER |

MINIMUM UNIT ORDER : 1000pcs PER EACH MODELS

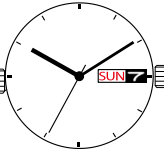
LEAD TIME(PRODUCTION BY ORDER) : 2 MONTHS~

| CAL. | | 2105-20A | 2105-20P | 2105-2PK | 2105-2PP | 2105-2TK |
|------------------|----------------|---|---|--|---|---|
| 10 1/2''' | |  |  |  |  |  |
| Dial Drawing | | PDF | PDF | PDF | PDF | PDF |
| Date | W.POSITION | 3H | 3H | 3H | 3H | 3H |
| | W.SHAPE | SQUARE | SQUARE | SQUARE | SQUARE | SQUARE |
| DAY | BACKGROUND | WHITE | BLACK | BLACK | BLACK | BLACK |
| | LETTER | BLACK | WHITE | WHITE | WHITE | WHITE |
| DAY | W. POSITION | 3H | 3H | 3H | 3H | 3H |
| | W.SHAPE | STRAIGHT | STRAIGHT | STRAIGHT | STRAIGHT | STRAIGHT |
| DAY | LANGUAGE | ENGLISH / SPANISH | ENGLISH / SPANISH | ENGLISH/ARABIC | ENGLISH / SPANISH | ENGLISH / ARABIC |
| | BACKGROUND | WHITE | BLACK | BLACK | BLACK | WHITE |
| DAY | LETTER | BLACK | WHITE | WHITE* | WHITE* | BLACK |
| | CROWN POSITION | 3H | 3H | 3H | 3H | 3H |
| ORDER | | STANDARD | PRODUCTION BY ORDER | PRODUCTION BY ORDER | PRODUCTION BY ORDER | PRODUCTION BY ORDER |

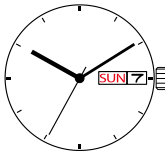
ENGLISH/SUNDAY RED LETTER

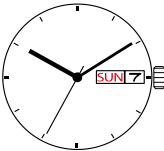
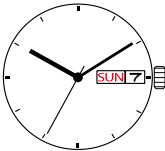
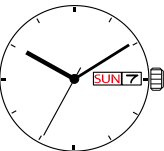
| CAL. | | 2105-2AD | 2105-2AE | 2105-2AG | 2105-2AI | 2105-2AK |
|------------------|----------------|---|---|--|---|---|
| 10 1/2''' | |  |  |  |  |  |
| Dial Drawing | | PDF | PDF | PDF | PDF | PDF |
| Date | W.POSITION | 3H | 3H | 3H | 3H | 3H |
| | W.SHAPE | SQUARE | SQUARE | SQUARE | SQUARE | SQUARE |
| DAY | BACKGROUND | WHITE | WHITE | WHITE | WHITE | WHITE |
| | LETTER | BLACK | BLACK | BLACK | BLACK | BLACK |
| DAY | W. POSITION | 3H | 3H | 3H | 3H | 3H |
| | W.SHAPE | STRAIGHT | STRAIGHT | STRAIGHT | STRAIGHT | STRAIGHT |
| DAY | LANGUAGE | ENGLISH / FRENCH | ENGLISH / GERMAN | ENGLISH / PORTUGUESE | ENGLISH / ITALY | ENGLISH / ARABIC |
| | BACKGROUND | WHITE | WHITE | WHITE | WHITE | WHITE |
| DAY | LETTER | BLACK | BLACK | BLACK | BLACK | BLACK |
| | CROWN POSITION | 3H | 3H | 3H | 3H | 3H |
| ORDER | | PRODUCTION BY ORDER | PRODUCTION BY ORDER | PRODUCTION BY ORDER | PRODUCTION BY ORDER | PRODUCTION BY ORDER |

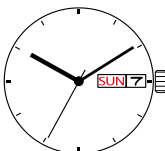
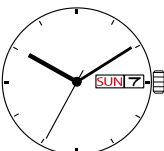
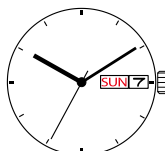
| CAL. | | 2105-2AM | 2105-2AN | 2105-2AQ | 2105-2AR |
|------------------|----------------|---|---|--|---|
| 10 1/2''' | |  |  |  |  |
| Dial Drawing | | PDF | PDF | PDF | PDF |
| Date | W.POSITION | 3H | 3H | 3H | 3H |
| | W.SHAPE | SQUARE | SQUARE | SQUARE | SQUARE |
| DAY | BACKGROUND | WHITE | WHITE | WHITE | WHITE |
| | LETTER | BLACK | BLACK | BLACK | BLACK |
| DAY | W. POSITION | 3H | 3H | 3H | 3H |
| | W.SHAPE | STRAIGHT | STRAIGHT | STRAIGHT | STRAIGHT |
| DAY | LANGUAGE | ENGLISH / HINDU | ENGLISH / JAPANESE | ENGLISH / CHINESE | ENGLISH / RUSSIAN |
| | BACKGROUND | WHITE | WHITE | WHITE | WHITE |
| DAY | LETTER | BLACK | BLACK | BLACK | BLACK |
| | CROWN POSITION | 3H | 3H | 3H | 3H |
| ORDER | | PRODUCTION BY ORDER | PRODUCTION BY ORDER | STANDARD | PRODUCTION BY ORDER |

MINIMUM UNIT ORDER : 1000pcs PER EACH MODELS

LEAD TIME(PRODUCTION BY ORDER) : 2 MONTHS~

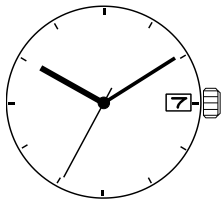
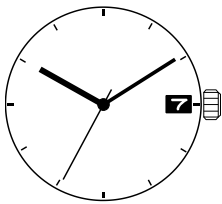
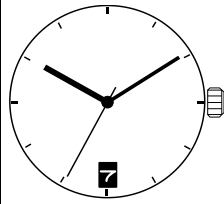
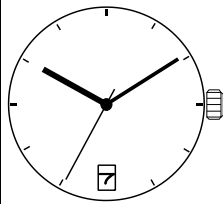
| CAL. | | 2315-20A | 2315-20P | 2315-20T | 2315-20Z |
|------------------|------------|---|---|--|---|
| 11 1/2''' | |  |  |  |  |
| Dial Drawing | | PDF | PDF | PDF | PDF |
| Date | W.POSITION | 3H | 3H | 6H | 6H |
| | W.SHAPE | SQUARE | SQUARE | SQUARE | SQUARE |
| Date | BACKGROUND | WHITE | BLACK | BLACK | WHITE |
| | LETTER | BLACK | WHITE | WHITE | BLACK |
| CROWN POSITION | | 3H | 3H | 3H | 3H |
| ORDER | | STANDARD | PRODUCTION BY ORDER | PRODUCTION BY ORDER | STANDARD |

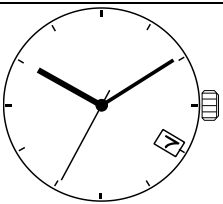
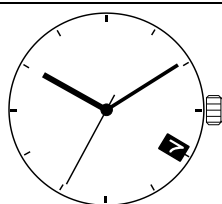
| CAL. | | 2315-2AZ | 2315-2PZ |
|------------------|------------|---|---|
| 11 1/2''' | |  |  |
| Dial Drawing | | PDF | PDF |
| Date | W.POSITION | 4H (SLA) | 4H (SLA) |
| | W.SHAPE | SQUARE | SQUARE |
| Date | BACKGROUND | WHITE | BLACK |
| | LETTER | BLACK | WHITE |
| CROWN POSITION | | 3H | 3H |
| ORDER | | PRODUCTION BY ORDER | PRODUCTION BY ORDER |

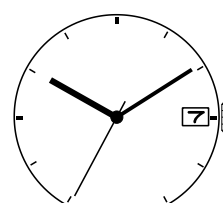
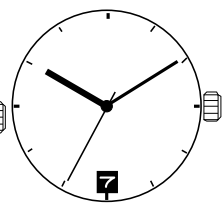
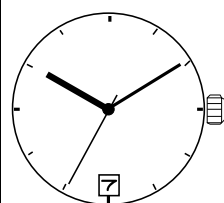
| CAL. | | 2317-20A | 2317-20T | 2317-20Z |
|--------------------------------|------------|---|---|--|
| 11 1/2''' High Hand | |  |  |  |
| Dial Drawing | | PDF | PDF | PDF |
| Date | W.POSITION | 3H | 6H | 6H |
| | W.SHAPE | SQUARE | SQUARE | SQUARE |
| Date | BACKGROUND | WHITE | BLACK | WHITE |
| | LETTER | BLACK | WHITE | BLACK |
| CROWN POSITION | | 3H | 3H | 3H |
| ORDER | | PRODUCTION BY ORDER | PRODUCTION BY ORDER | PRODUCTION BY ORDER |

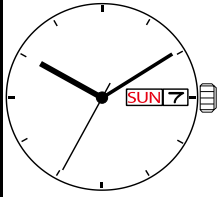
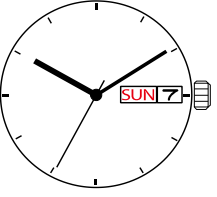
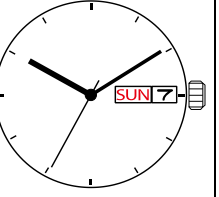
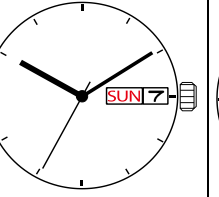
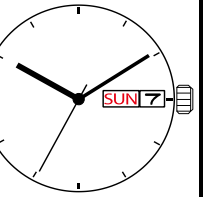

MINIMUM UNIT ORDER : 1000pcs PER EACH MODELS

LEAD TIME(PRODUCTION BY ORDER) : 2 MONTHS~

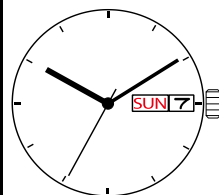
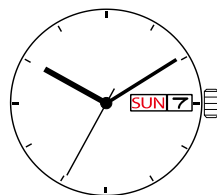
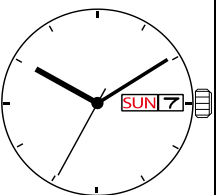
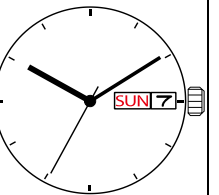
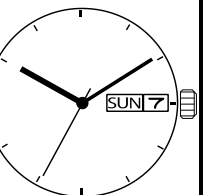
| CAL. | | 2305-20A | 2305-2AD | 2305-2AE | 2305-2AG | 2305-2AI |
|----------------|----------------|---|---|--|---|---|
| <u>11 1/2"</u> | |  |  |  |  |  |
| Dial Drawing | | PDF | PDF | PDF | PDF | PDF |
| Date | W.POSITION | 3H | 3H | 3H | 3H | 3H |
| | W.SHAPE | SQUARE | SQUARE | SQUARE | SQUARE | SQUARE |
| DAY | BACKGROUND | WHITE | WHITE | WHITE | WHITE | WHITE |
| | LETTER | BLACK | BLACK | BLACK | BLACK | BLACK |
| DAY | W. POSITION | 3H | 3H | 3H | 3H | 3H |
| | W.SHAPE | STRAIGHT | STRAIGHT | STRAIGHT | STRAIGHT | STRAIGHT |
| DAY | LANGUAGE | ENGLISH / SPANISH | ENGLISH / FRENCH | ENGLISH / GERMAN | ENGLISH / PORTUGUESE | ENGLISH / ITALIAN |
| | BACKGROUND | WHITE | WHITE | WHITE | WHITE | WHITE |
| DAY | LETTER | BLACK | BLACK | BLACK | BLACK | BLACK |
| | CROWN POSITION | 3H | 3H | 3H | 3H | 3H |
| ORDER | | STANDARD | PRODUCTION BY ORDER | PRODUCTION BY ORDER | PRODUCTION BY ORDER | PRODUCTION BY ORDER |

| CAL. | | 2305-2AK | 2305-2AN | 2305-2AR | 2305-2AU | 2305-2AW |
|----------------|----------------|--|--|---|--|--|
| <u>11 1/2"</u> | |  |  |  |  |  |
| Dial Drawing | | PDF | PDF | PDF | PDF | PDF |
| Date | W.POSITION | 3H | 3H | 3H | 3H | 3H |
| | W.SHAPE | SQUARE | SQUARE | SQUARE | SQUARE | SQUARE |
| DAY | BACKGROUND | WHITE | WHITE | WHITE | WHITE | WHITE |
| | LETTER | BLACK | BLACK | BLACK | BLACK | BLACK |
| DAY | W. POSITION | 3H | 3H | 3H | 3H | 3H |
| | W.SHAPE | STRAIGHT | STRAIGHT | STRAIGHT | STRAIGHT | STRAIGHT |
| DAY | LANGUAGE | ENGLISH / ARABIC | ENGLISH / JAPANESE | ENGLISH / RUSSIAN | ENGLISH / CHINESE | ENGLISH / SPANISH |
| | BACKGROUND | WHITE | WHITE | WHITE | WHITE | WHITE |
| DAY | LETTER | BLACK | BLACK | BLACK | BLACK | BLACK* |
| | CROWN POSITION | 3H | 3H | 3H | 3H | 3H |
| ORDER | | PRODUCTION BY ORDER | PRODUCTION BY ORDER | PRODUCTION BY ORDER | STANDARD | PRODUCTION BY ORDER |

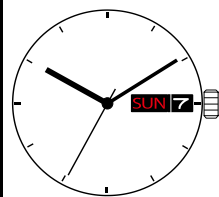
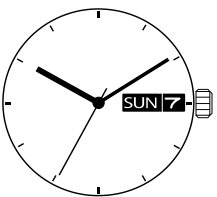
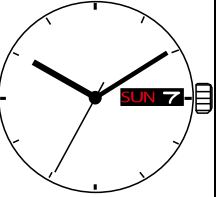
*SUNDAY BLACK LETTER

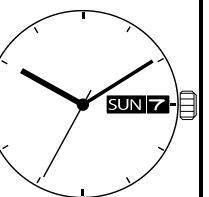
| CAL. | | 2305-2PC | 2305-2PD | 2305-2PK | 2305-2PU | 2305-2PW |
|----------------|----------------|---|---|--|---|---|
| <u>11 1/2"</u> | |  |  |  |  |  |
| Dial Drawing | | PDF | PDF | PDF | PDF | PDF |
| Date | W.POSITION | 3H | 3H | 3H | 3H | 3H |
| | W.SHAPE | SQUARE | SQUARE | SQUARE | SQUARE | SQUARE |
| DAY | BACKGROUND | BLACK | BLACK | BLACK | BLACK | BLACK |
| | LETTER | WHITE | WHITE | WHITE | WHITE | WHITE |
| DAY | W. POSITION | 3H | 3H | 3H | 3H | 3H |
| | W.SHAPE | STRAIGHT | STRAIGHT | STRAIGHT | STRAIGHT | STRAIGHT |
| DAY | LANGUAGE | ENGLISH / SPANISH | ENGLISH / FRENCH | ENGLISH / ARABIC | ENGLISH / CHINESE | ENGLISH / SPANISH |
| | BACKGROUND | BLACK | BLACK | BLACK | BLACK | BLACK |
| DAY | LETTER | WHITE | WHITE* | WHITE | WHITE | WHITE* |
| | CROWN POSITION | 3H | 3H | 3H | 3H | 3H |
| ORDER | | PRODUCTION BY ORDER | PRODUCTION BY ORDER | PRODUCTION BY ORDER | PRODUCTION BY ORDER | PRODUCTION BY ORDER |

*SUNDAY WHITE LETTER

*SUNDAY WHITE LETTER

MINIMUM UNIT ORDER : 1000pcs PER EACH MODELS

LEAD TIME(PRODUCTION BY ORDER) : 2MONTHS~

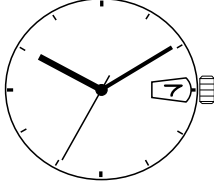
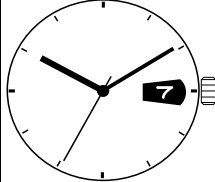
| CAL. | | 2353-20A | 2353-20P |
|----------------|------------|---|---|
| 11 1/2" | |  |  |
| Dial Drawing | | PDF | PDF |
| Date | W.POSITION | 3H | 3H |
| | W.SHAPE | ENLARGED | ENLARGED |
| DAY | BACKGROUND | WHITE | BLACK |
| | LETTER | BLACK | WHITE |
| CROWN POSITION | | 3H | 3H |
| ORDER | | STANDARD | PRODUCTION BY ORDER |

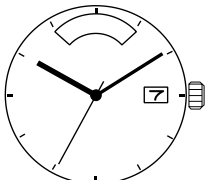
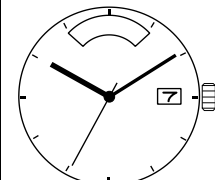
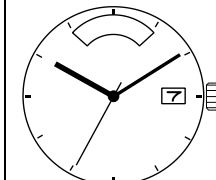
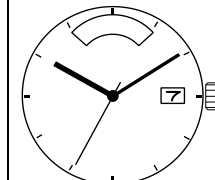
| CAL. | | 2350-20A | 2350-2AE | 2350-2AG | 2350-2AU |
|----------------|------------|--|--|---|--|
| 11 1/2" | |  |  |  |  |
| Dial Drawing | | PDF | PDF | PDF | PDF |
| Date | W.POSITION | 3H | 3H | 3H | 3H |
| | W.SHAPE | SQUARE | SQUARE | SQUARE | SQUARE |
| DAY | BACKGROUND | WHITE | WHITE | WHITE | WHITE |
| | LETTER | BLACK | BLACK | BLACK | BLACK |
| CROWN POSITION | | 3H | 3H | 3H | 3H |
| ORDER | | STANDARD | PRODUCTION BY ORDER | PRODUCTION BY ORDER | PRODUCTION BY ORDER |

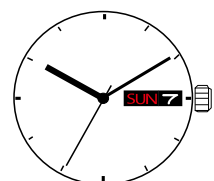
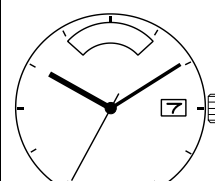
| CAL. | | 2307-2PC | 2357-20A |
|------------------------------------|------------|---|---|
| 11 1/2" High Hand | |  |  |
| Dial Drawing | | PDF | PDF |
| Date | W.POSITION | 3H | 3H |
| | W.SHAPE | SQUARE | SQUARE |
| DAY | BACKGROUND | BLACK | WHITE |
| | LETTER | WHITE | BLACK |
| CROWN POSITION | | 3H | 3H |
| ORDER | | PRODUCTION BY ORDER | PRODUCTION BY ORDER |

MINIMUM UNIT ORDER : 1000pcs PER EACH MODELS

LEAD TIME(PRODUCTION BY ORDER) : 2 MONTHS~

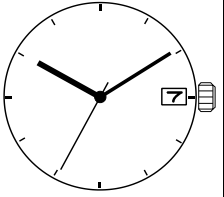
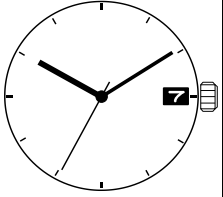
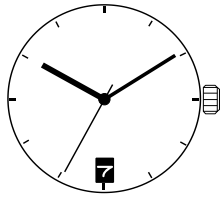
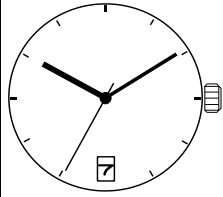
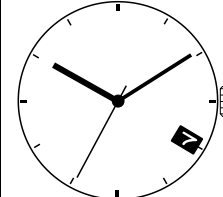
| CAL. | | 2415-20A | 2415-20P | 2415-20T | 2415-20Z | 2415-2PZ |
|-----------------------|------------|---|---|--|---|---|
| <u>13 1/2"</u> | |  |  |  |  |  |
| Dial Drawing | | PDF | PDF | PDF | PDF | PDF |
| Date | W.POSITION | 3H | 3H | 6H | 6H | 4H (SLA) |
| | W.SHAPE | SQUARE | SQUARE | SQUARE | SQUARE | SQUARE |
| | BACKGROUND | WHITE | BLACK | BLACK | WHITE | BLACK |
| | LETTER | BLACK | WHITE | WHITE | BLACK | WHITE |
| CROWN POSITION | | 3H | 3H | 3H | 3H | 3H |
| ORDER | | STANDARD | PRODUCTION BY ORDER | PRODUCTION BY ORDER | STANDARD | PRODUCTION BY ORDER |

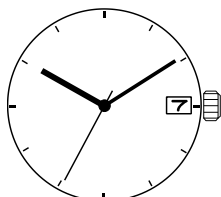
| CAL. | | 2417-20A |
|---|------------|---|
| <u>13 1/2"</u> High Hand | |  |
| Dial Drawing | | PDF |
| Date | W.POSITION | 3H |
| | W.SHAPE | SQUARE |
| | BACKGROUND | WHITE |
| | LETTER | BLACK |
| CROWN POSITION | | 3H |
| ORDER | | PRODUCTION BY ORDER |

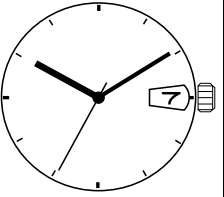
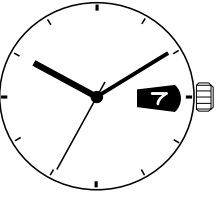
| CAL. | | 2453-20A | 2453-20X |
|-----------------------|------------|---|---|
| <u>13 1/2"</u> | |  |  |
| Dial Drawing | | PDF | PDF |
| Date | W.POSITION | 3H | 3H |
| | W.SHAPE | ENLARGED | ENLARGED |
| | BACKGROUND | WHITE | BLACK |
| | LETTER | BLACK | WHITE |
| CROWN POSITION | | 3H | 3H |
| ORDER | | STANDARD | PRODUCTION BY ORDER |

MINIMUM UNIT ORDER : 1000pcs PER EACH MODELS

LEAD TIME(PRODUCTION BY ORDER) : 2 MONTHS~

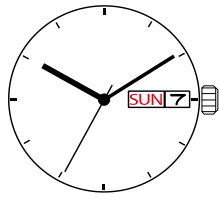
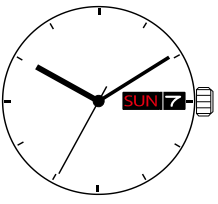
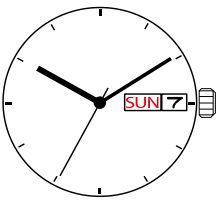
| CAL. | | 2405-20A | 2405-20P | 2405-2AU |
|------------------|----------------|---|---|--|
| <u>13 1/2'''</u> | |  |  |  |
| Dial Drawing | | PDF | PDF | PDF |
| Date | W.POSITION | 3H | 3H | 3H |
| | W.SHAPE | SQUARE | SQUARE | SQUARE |
| DAY | BACKGROUND | WHITE | BLACK | WHITE |
| | LETTER | BLACK | WHITE | BLACK |
| DAY | W. POSITION | 3H | 3H | 3H |
| | W.SHAPE | STRAIGHT | STRAIGHT | STRAIGHT |
| DAY | LANGUAGE | ENGLISH / SPANISH | ENGLISH / SPANISH | ENGLISH / CHINESE |
| | BACKGROUND | WHITE | BLACK | WHITE |
| DAY | LETTER | BLACK | WHITE | BLACK |
| | CROWN POSITION | 3H | 3H | 3H |
| ORDER | | STANDARD | PRODUCTION BY ORDER | PRODUCTION BY ORDER |

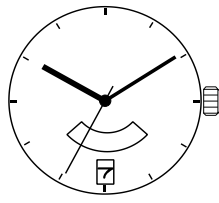
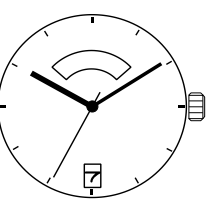
| CAL. | | 2405-2XX | 2405-2XY |
|------------------|----------------|--|--|
| <u>13 1/2'''</u> | |  |  |
| Dial Drawing | | PDF | PDF |
| Date | W.POSITION | 6H | 6H |
| | W.SHAPE | SQUARE | SQUARE |
| DAY | BACKGROUND | WHITE | WHITE |
| | LETTER | BLACK | BLACK |
| DAY | W. POSITION | 6H | 12H |
| | W.SHAPE | ARC | ARC |
| DAY | LANGUAGE | ENGLISH | ENGLISH |
| | BACKGROUND | WHITE | WHITE |
| DAY | LETTER | BLACK | BLACK |
| | CROWN POSITION | 3H | 3H |
| ORDER | | PRODUCTION BY ORDER | PRODUCTION BY ORDER |