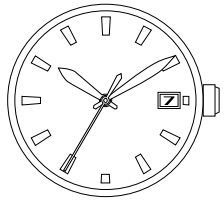
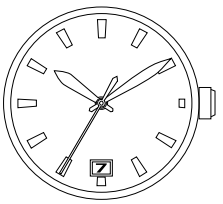
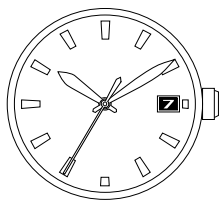
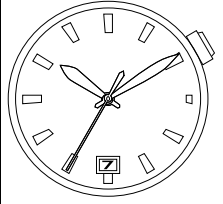
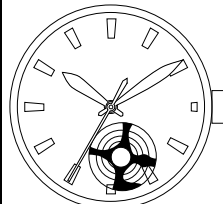
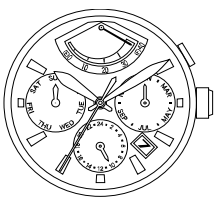
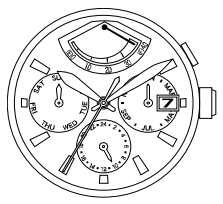
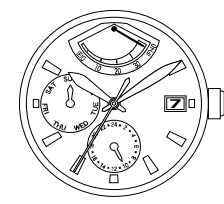
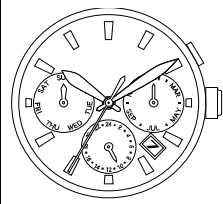
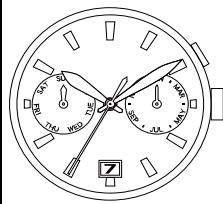
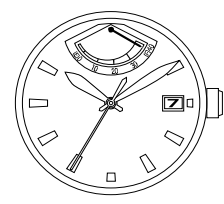
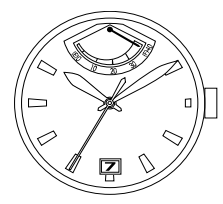
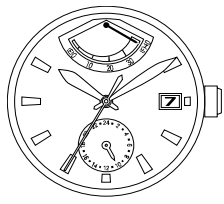
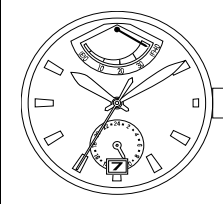
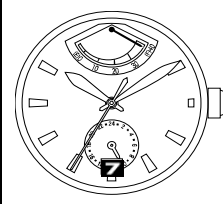

MINIMUM UNIT ORDER : 1000pcs PER EACH MODELS

LEAD TIME(PRODUCTION BY ORDER) : TO BE ADVISED

CAL.		9015-20A	9015-20Y	9015-20Z	9015-2ZZ	90S5-20A
<u>11 1/2"</u>						
Dial Drawing		PDF	PDF	PDF	PDF	PDF
Date	W.POSITION	3H	6H	3H	6H	/
	W.SHAPE	SQUARE	SQUARE	SQUARE	SQUARE	
BACKGROUND		WHITE	WHITE	BLACK	WHITE	
LETTER		BLACK	BLACK	WHITE	BLACK	
CROWN POSITION		3H	3H	3H	2H	3H
ORDER		STANDARD	PRODUCTION BY ORDER	PRODUCTION BY ORDER	PRODUCTION BY ORDER	STANDARD

CAL.		9100-20A	9100-20Y	9110-20A	9120-20A	9122-20A
<u>13 1/2"</u>						
Dial Drawing		PDF	PDF	PDF	PDF	PDF
Date	W.POSITION	4.5H(SLA)	3H	3H	4.5H(SLA)	4.5H(SLA)
	W.SHAPE	SQUARE	SQUARE	SQUARE	SQUARE	SQUARE
BACKGROUND		WHITE	WHITE	WHITE	WHITE	WHITE
LETTER		BLACK	BLACK	BLACK	BLACK	BLACK
CROWN POSITION		3H	3H	3H	3H	3H
ORDER		STANDARD	PRODUCTION BY ORDER	PRODUCTION BY ORDER	PRODUCTION BY ORDER	PRODUCTION BY ORDER

CAL.		9130-20A	9130-20Z	9132-20A	9132-20Z	9132-20X
<u>13 1/2"</u>						
Dial Drawing		PDF	PDF	PDF	PDF	PDF
Date	W.POSITION	3H	6H	3H	6H	6H
	W.SHAPE	SQUARE	SQUARE	SQUARE	SQUARE	SQUARE
BACKGROUND		WHITE	WHITE	WHITE	WHITE	BLACK
LETTER		BLACK	BLACK	BLACK	BLACK	WHITE
CROWN POSITION		3H	3H	3H	3H	3H
ORDER		PRODUCTION BY ORDER	PRODUCTION BY ORDER	PRODUCTION BY ORDER	PRODUCTION BY ORDER	PRODUCTION BY ORDER

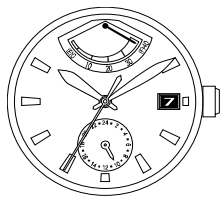

CAL.		9132-2AV
<u>13 1/2"</u>		
Dial Drawing		PDF
Date	W.POSITION	3H
	W.SHAPE	SQUARE
BACKGROUND		BLACK
LETTER		WHITE
CROWN POSITION		3H
ORDER		PRODUCTION BY ORDER

MINIMUM UNIT ORDER : 1000pcs PER EACH MODELS

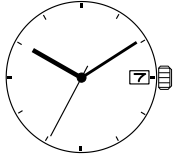
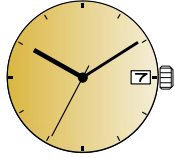
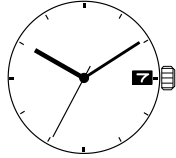
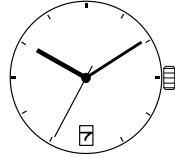

LEAD TIME(PRODUCTION BY ORDER) : TO BE ADVISED

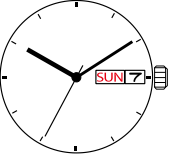
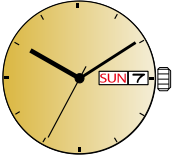
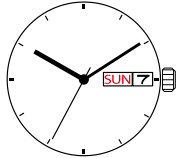
CAL.		8215-21A	8215-21C*	8215-1AV	8215-1TH
11 1/2'''					
Dial Drawing		PDF	PDF	PDF	PDF
Date	W.POSITION W.SHAPE BACKGROUND LETTER	3H SQUARE WHITE BLACK	3H SQUARE WHITE BLACK	3H SQUARE BLACK WHITE	6H SQUARE WHITE BLACK
CROWN POSITION		3H	3H	3H	3H
ORDER		STANDARD	PRODUCTION BY ORDER	PRODUCTION BY ORDER	PRODUCTION BY ORDER

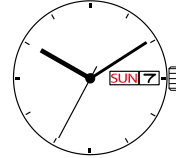
*Movement GILT

CAL.		8205-21E	8205-21P*	8205-1ED	8205-1EE	8205-1EN
11 1/2'''						
Dial Drawing		PDF	PDF	PDF	PDF	PDF
Date	W.POSITION W.SHAPE BACKGROUND LETTER	3H SQUARE WHITE BLACK	3H SQUARE WHITE BLACK	3H SQUARE WHITE BLACK	3H SQUARE WHITE BLACK	3H SQUARE WHITE BLACK
DAY	W. POSITION W.SHAPE LANGUAGE BACKGROUND LETTER	3H STRAIGHT ENGLISH / SPANISH WHITE BLACK	3H STRAIGHT ENGLISH / SPANISH WHITE BLACK	3H STRAIGHT ENGLISH / FRENCH WHITE BLACK	3H STRAIGHT ENGLISH / GERMAN WHITE BLACK	3H STRAIGHT ENGLISH / JAPANESE WHITE BLACK
CROWN POSITION		3H	3H	3H	3H	3H
ORDER		STANDARD	PRODUCTION BY ORDER	PRODUCTION BY ORDER	PRODUCTION BY ORDER	PRODUCTION BY ORDER

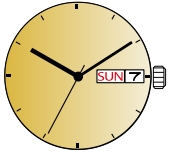
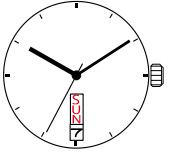
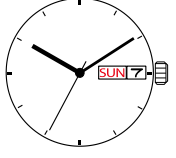
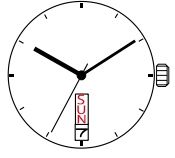
*Movement GILT

CAL.		8205-1PU*	8205-1TA	8205-AEB	8205-ETU	8205-AVB
11 1/2'''						
Dial Drawing		PDF	PDF	PDF	PDF	PDF
Date	W.POSITION W.SHAPE BACKGROUND LETTER	3H SQUARE WHITE BLACK	6H SQUARE WHITE BLACK	3H SQUARE WHITE BLACK	6H SQUARE WHITE BLACK	3H SQUARE BLACK WHITE
DAY	W. POSITION W.SHAPE LANGUAGE BACKGROUND LETTER	3H STRAIGHT ENGLISH / CHINESE WHITE BLACK	6H VERTICAL ENGLISH / SPANISH WHITE BLACK	3H STRAIGHT ENGLISH / CHINESE WHITE BLACK	6H VERTICAL ENGLISH / CHINESE WHITE BLACK	3H STRAIGHT ENGLISH / CHINESE BLACK WHITE
CROWN POSITION		3H	3H	3H	3H	3H
ORDER		PRODUCTION BY ORDER	PRODUCTION BY ORDER	STANDARD	PRODUCTION BY ORDER	PRODUCTION BY ORDER

*Movement GILT

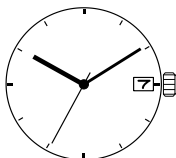
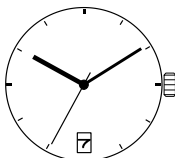
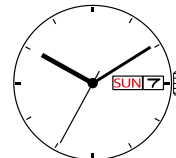
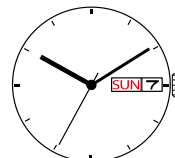
CAL.		821A-21C	821A-21Z	820A-21C	820A-AEB
11 1/2''' Fine Finishing					
Dial Drawing		PDF	PDF	PDF	PDF
Date	W.POSITION W.SHAPE BACKGROUND LETTER	3H SQUARE WHITE BLACK	6H SQUARE WHITE BLACK	3H SQUARE WHITE BLACK	3H SQUARE WHITE BLACK
DAY	W. POSITION W.SHAPE LANGUAGE BACKGROUND LETTER			3H STRAIGHT ENGLISH / CHINESE WHITE BLACK	3H STRAIGHT ENGLISH / SPANISH WHITE BLACK
CROWN POSITION		3H	3H	3H	3H
ORDER		STANDARD	PRODUCTION BY ORDER	STANDARD	PRODUCTION BY ORDER

MINIMUM UNIT ORDER : 1000pcs PER EACH MODELS

LEAD TIME(PRODUCTION BY ORDER) : TO BE ADVISED

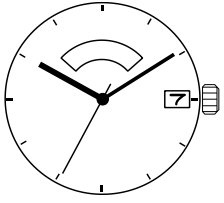
CAL.		8285-21B
13'''		
Dial Drawing		PDF
Date	W.POSITION W.SHAPE BACKGROUND LETTER	3H SQUARE WHITE BLACK
DAY	W. POSITION W.SHAPE LANGUAGE BACKGROUND LETTER	12H ARC ENGLISH WHITE BLACK
CROWN POSITION		3H
ORDER		STANDARD

MINIMUM UNIT ORDER : 1000pcs PER EACH MODELS

LEAD TIME(PRODUCTION BY ORDER) : TO BE ADVISED

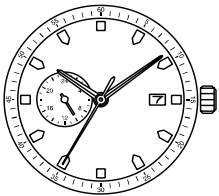
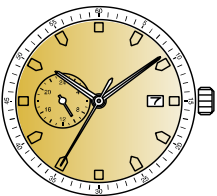
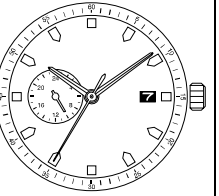
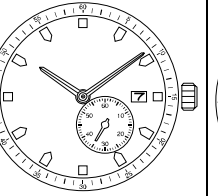
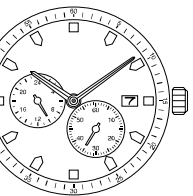
CAL.		8217-21A	8217-21G*	8217-2AV	8218-21A	8219-21A
11 1/2''' Fine Finishing						
Dial Drawing		PDF	PDF	PDF	PDF	PDF
Date	W.POSITION	3H	3H	3H	3H	3H
	W.SHAPE	SQUARE	SQUARE	SQUARE	SQUARE	SQUARE
BACKGROUND		WHITE	WHITE	BLACK	WHITE	WHITE
LETTER		BLACK	BLACK	WHITE	BLACK	BLACK
CROWN POSITION		3H	3H	3H	3H	3H
ORDER		STANDARD	PRODUCTION BY ORDER	PRODUCTION BY ORDER	STANDARD	STANDARD

*Movement GILT

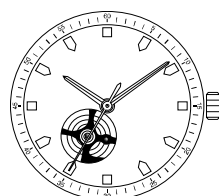
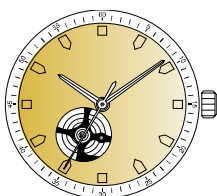
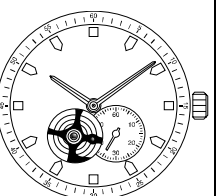
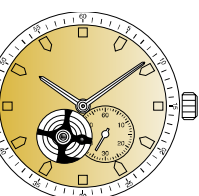
CAL.		82S0-21A	82S0-21G*	82S5-21A	82S5-21G*
11 1/2''' Fine Finishing					
Dial Drawing		PDF	PDF	PDF	PDF
CROWN POSITION		3H	3H	3H	3H
ORDER		STANDARD	PRODUCTION BY ORDER	STANDARD	PRODUCTION BY ORDER

*Movement GILT

*Movement GILT

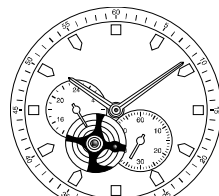
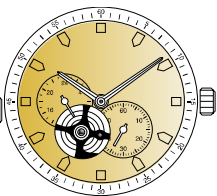
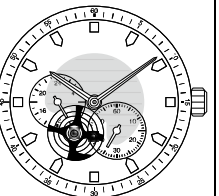
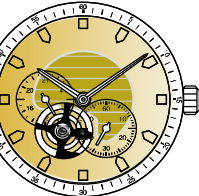
CAL.		82S7-21A	82S7-21G*	82D7-43A	82D7-43G
11 1/2''' Fine Finishing					
Dial Drawing		PDF	PDF	PDF	PDF
CROWN POSITION		3H	3H	3H	3H
ORDER		STANDARD	PRODUCTION BY ORDER	STANDARD	STANDARD

*Movement GILT

*Movement GILT

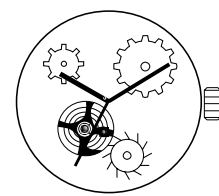
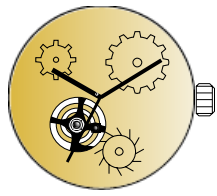
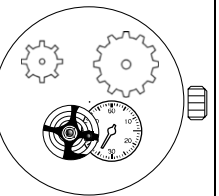
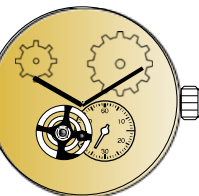
CAL.		8N24-E21	8N24-D21*	8N40-E21	8N40-D21*
11 1/2'''					
Dial Drawing		PDF	PDF	PDF	PDF
CROWN POSITION		3H	3H	3H	3H
ORDER		STANDARD	STANDARD	STANDARD	STANDARD

*Movement GILT

*Movement GILT

MINIMUM UNIT ORDER : 1000pcs PER EACH MODELS

LEAD TIME(PRODUCTION BY ORDER) : TO BE ADVISED

CAL.		821A-21C	821A-21Z	820A-21C	820A-AEB
11 1/2" Fine Finishing					
Dial Drawing		PDF	PDF	PDF	PDF
Date	W.POSITION W.SHAPE BACKGROUND LETTER	3H SQUARE WHITE BLACK	6H SQUARE WHITE BLACK	3H SQUARE WHITE BLACK	3H SQUARE WHITE BLACK
DAY	W. POSITION W.SHAPE LANGUAGE BACKGROUND LETTER			3H STRAIGHT ENGLISH / CHINESE WHITE BLACK	3H STRAIGHT ENGLISH / SPANISH WHITE BLACK
CROWN POSITION		3H	3H	3H	3H
ORDER		STANDARD	PRODUCTION BY ORDER	STANDARD	PRODUCTION BY ORDER

CAL.		8217-21A	8217-21G*	8217-2AV	8218-21A	8219-21A
11 1/2" Fine Finishing						
Dial Drawing		PDF	PDF	PDF	PDF	PDF
Date	W.POSITION W.SHAPE BACKGROUND LETTER	3H SQUARE WHITE BLACK	3H SQUARE WHITE BLACK	3H SQUARE BLACK WHITE	3H SQUARE WHITE BLACK	3H SQUARE WHITE BLACK
CROWN POSITION		3H	3H	3H	3H	3H
ORDER		STANDARD	PRODUCTION BY ORDER	PRODUCTION BY ORDER	STANDARD	STANDARD

*Movement GILT

CAL.		82S0-21A	82S0-21G*	82S5-21A	82S5-21G*
11 1/2" Fine Finishing					
Dial Drawing		PDF	PDF	PDF	PDF
CROWN POSITION		3H	3H	3H	3H
ORDER		STANDARD	PRODUCTION BY ORDER	STANDARD	PRODUCTION BY ORDER

*Movement GILT

*Movement GILT

CAL.		82S7-21A	82S7-21G*	82D7-43A	82D7-43G
11 1/2" Fine Finishing					
Dial Drawing		PDF	PDF	PDF	PDF
CROWN POSITION		3H	3H	3H	3H
ORDER		STANDARD	PRODUCTION BY ORDER	STANDARD	STANDARD

*Movement GILT

*Movement GILT

MINIMUM UNIT ORDER : 1000pcs PER EACH MODELS

LEAD TIME(PRODUCTION BY ORDER) : TO BE ADVISED

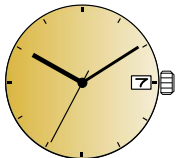
CAL.		8215-21C*
<u>11 1/2'''</u>		
Dial Drawing		PDF
Date	W.POSITION	3H
	W.SHAPE	SQUARE
	BACKGROUND	WHITE
	LETTER	BLACK
CROWN POSITION		3H
ORDER		PRODUCTION BY ORDER

*Movement GILT

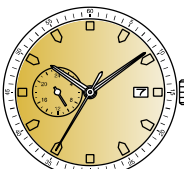
CAL.		8217-21G*
<u>11 1/2'''</u> Fine Finishing		
Dial Drawing		PDF
Date	W.POSITION	3H
	W.SHAPE	SQUARE
	BACKGROUND	WHITE
	LETTER	BLACK
CROWN POSITION		3H
ORDER		PRODUCTION BY ORDER

*Movement GILT

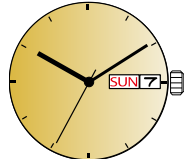
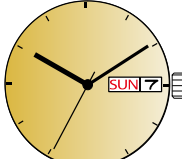
CAL.		8205-21P*	8205-1PU*
<u>11 1/2'''</u>			
Dial Drawing		PDF	PDF
Date	W.POSITION	3H	3H
	W.SHAPE	SQUARE	SQUARE
	BACKGROUND	WHITE	WHITE
DAY	LETTER	BLACK	BLACK
	W. POSITION	3H	3H
	W.SHAPE	STRAIGHT	STRAIGHT
LANGUAGE		ENGLISH / SPANISH	ENGLISH / CHINESE
BACKGROUND		WHITE	WHITE
LETTER		BLACK	BLACK
CROWN POSITION		3H	3H
ORDER		PRODUCTION BY ORDER	PRODUCTION BY ORDER

*Movement GILT

*Movement GILT

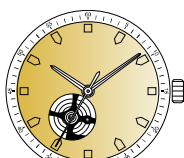
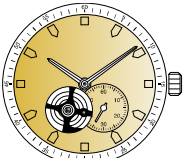
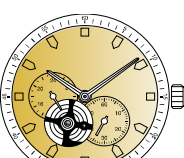
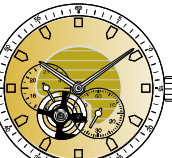
CAL.		82S0-21G*	82S5-21G*	82S7-21G*	82D7-43G
<u>11 1/2'''</u> Fine Finishing					
Dial Drawing		PDF	PDF	PDF	PDF
CROWN POSITION		3H	3H	3H	3H
ORDER		PRODUCTION BY ORDER	PRODUCTION BY ORDER	PRODUCTION BY ORDER	STANDARD

*Movement GILT

*Movement GILT

*Movement GILT

*Movement GILT

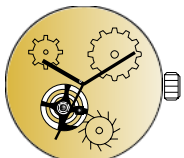
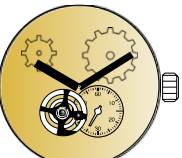
CAL.		8N24-D21*	8N40-D21*
<u>11 1/2'''</u>			
Dial Drawing		PDF	PDF
CROWN POSITION		3H	3H
ORDER		STANDARD	STANDARD

*Movement GILT

*Movement GILT

MINIMUM UNIT ORDER : 1000pcs PER EACH MODELS

LEAD TIME(PRODUCTION BY ORDER) : TO BE ADVISED

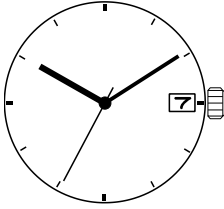
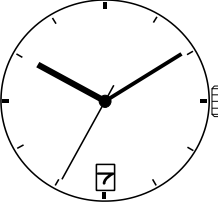
CAL.		6T15-21A	6T15-1TH
<u>8 3/4"</u>			
Dial Drawing		PDF	PDF
Date	W.POSITION W.SHAPE BACKGROUND LETTER	3H SQUARE WHITE BLACK	6H SQUARE WHITE BLACK
CROWN POSITION		3H	3H
ORDER		STANDARD	STANDARD

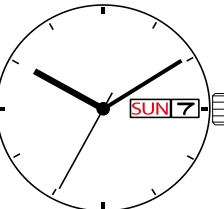
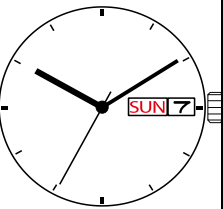
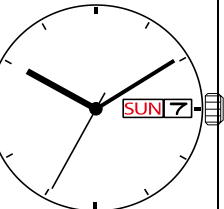
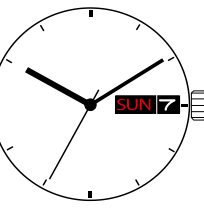
CAL.		6T51-21A	6T51-1AE	6T51-AAQ	6T51-AAP
<u>8 3/4"</u>					
Dial Drawing		PDF	PDF	PDF	PDF
Date	W.POSITION W.SHAPE BACKGROUND LETTER	3H SQUARE WHITE BLACK	3H SQUARE WHITE BLACK	3H SQUARE WHITE BLACK	3H SQUARE BLACK WHITE
DAY	W. POSITION W.SHAPE LANGUAGE BACKGROUND LETTER	3H STRAIGHT ENGLISH / SPANISH WHITE BLACK	3H STRAIGHT ENGLISH / GERMAN WHITE BLACK	3H STRAIGHT ENGLISH / CHINESE WHITE BLACK	3H STRAIGHT ENGLISH / CHINESE BLACK WHITE
CROWN POSITION		3H	3H	3H	3H
ORDER		STANDARD	PRODUCTION BY ORDER	STANDARD	PRODUCTION BY ORDER

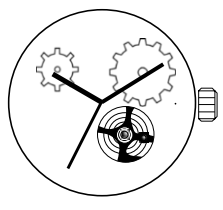
CAL.		6T28-21A
<u>8 3/4"</u>		
Dial Drawing		PDF
CROWN POSITION		3H
ORDER		STANDARD