

This drawing is provisional and subject to our reconfirmation and/or revision without notice.

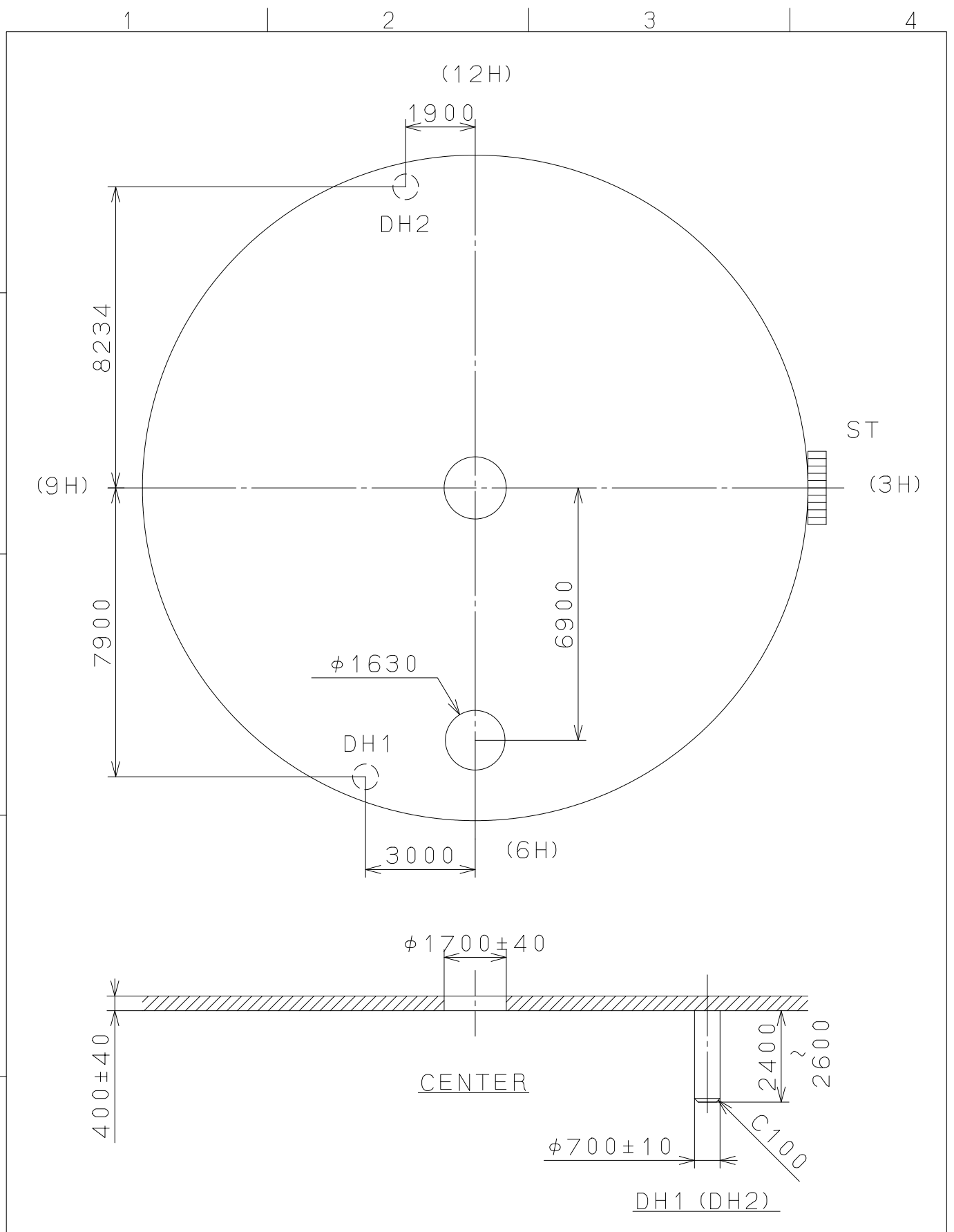

△			Quantity		Cal.NO.:
△			Unit	1 / 1000 mm	2015-30Z
△			Scale	7 : 1	Parts No.:
△			Date		
△			Drawn		
Mark	Date	Description	Appr.	Checked	Name:
		Alterations	Approved	D. Yamada	Indications for Dial
Material					Drawing No.: 201501D1
Heat Treatment				General Tolerances	MIYOTA
Hardness				Dimensions	
Plating				Angles	
					CITIZEN WATCH CO., LTD. TOKYO, JAPAN