

This drawing is provisional and subject to our reconfirmation and/or revision without notice.

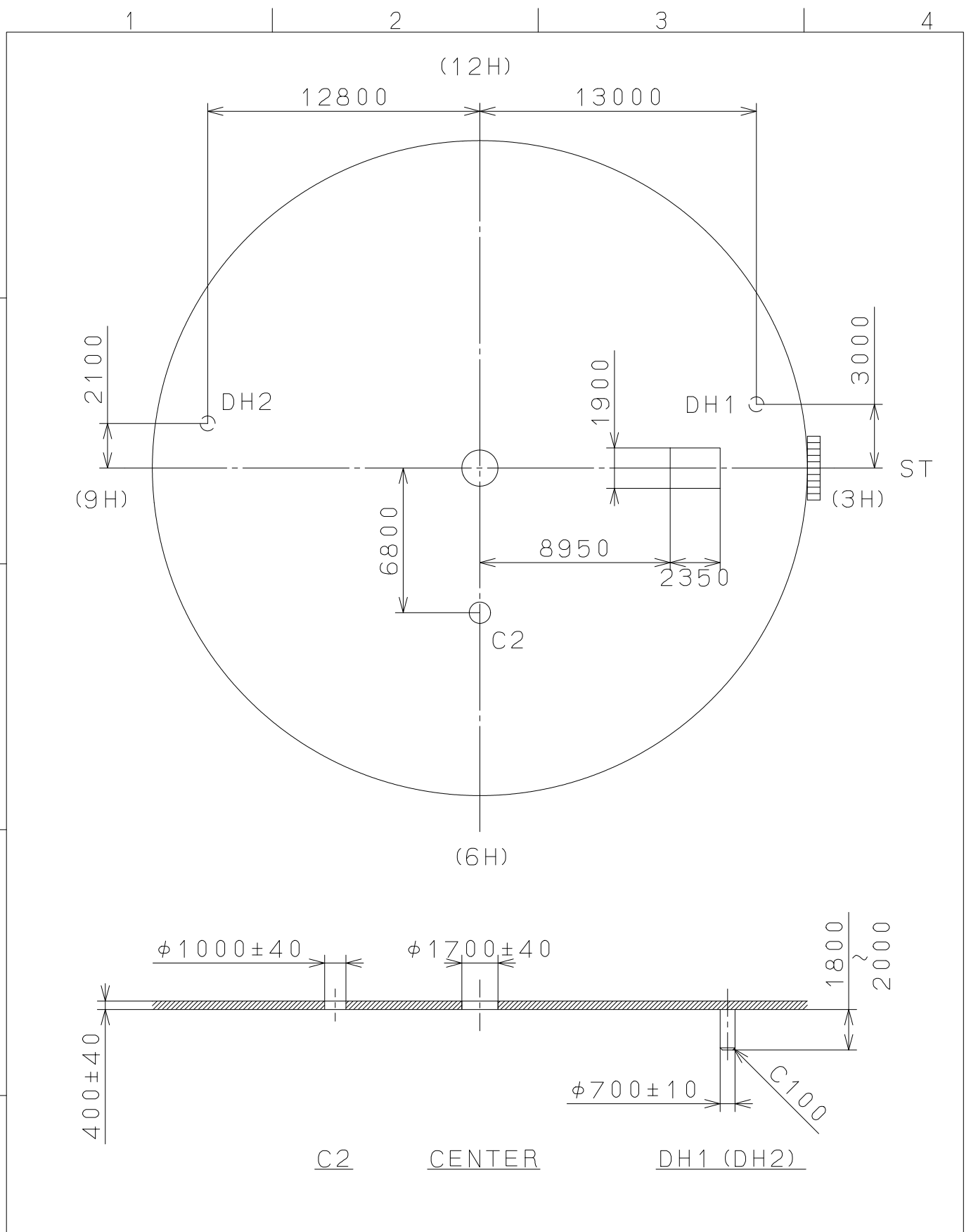

△			Quantity		Cal.NO.:
△			Unit	1 / 1000 mm	OT45-00A
△			Scale	4 : 1	Parts No.:
△			Date		
△			Drawn		
Mark	Date	Description	Appr.	Checked	M. Kobayashi
Alterations			Approved	Name:	
Material					Indications for Dial
Heat Treatment					Drawing No.: OT45D000
Hardness					MIYOTA
Plating					