

This drawing is provisional and subject to our reconfirmation and/or revision without notice.

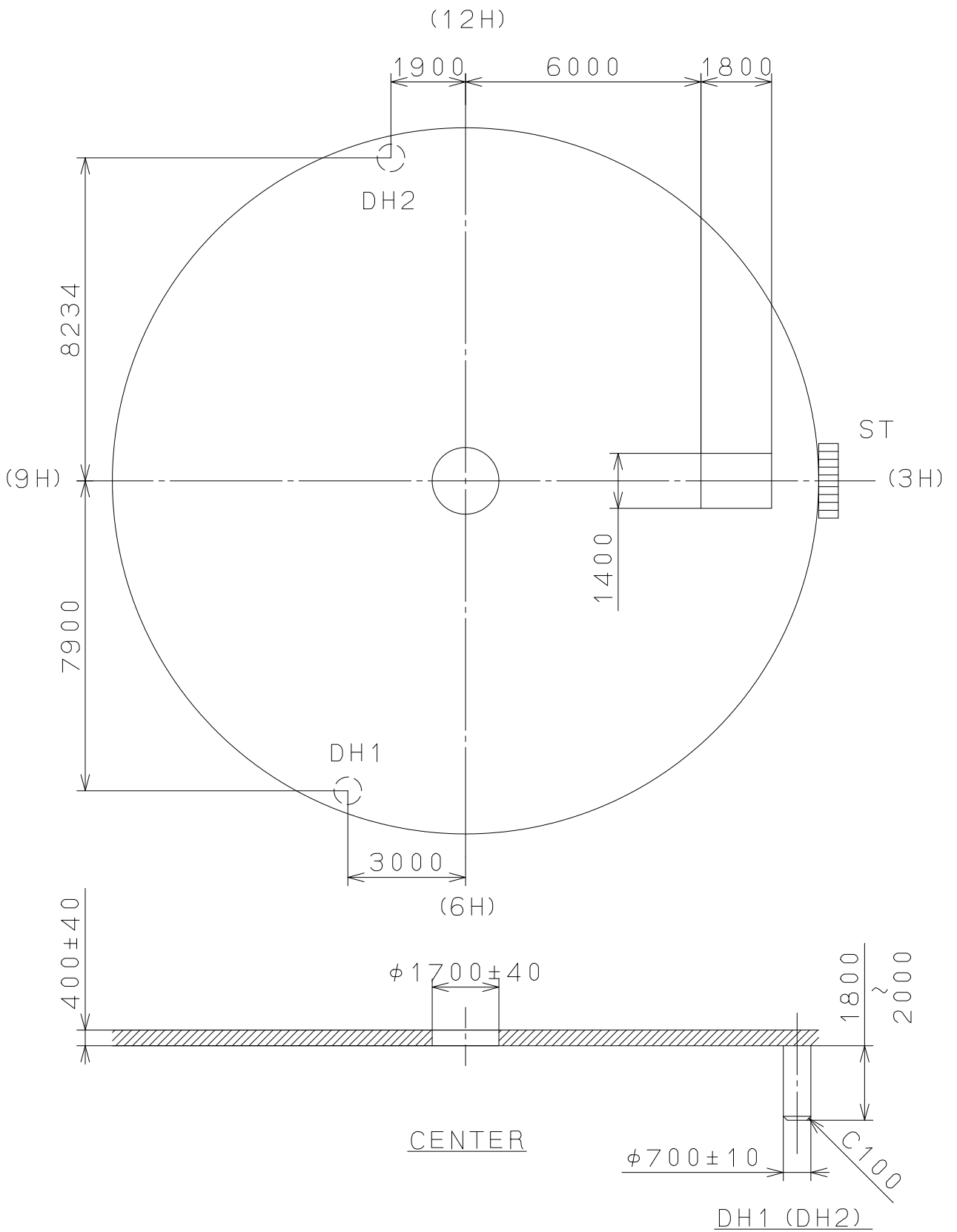

△			Quantity		Cal.NO.:
△			Unit	1 / 1000 mm	GL17-10A
△			Scale	7 : 1	Parts No.:
△			Date		
△			Drawn		
Mark	Date	Description	Appr.	Checked	Name:
		Alterations	Approved	D. Yamada	Indications for Dial
Material					Drawing No.: GL1700D0
Heat Treatment			General Tolerances	MIYOTA CITIZEN WATCH CO., LTD. TOKYO, JAPAN	
Hardness			Dimensions		
Plating			Angles		