

This drawing is provisional and subject to our reconfirmation and/or revision without notice.

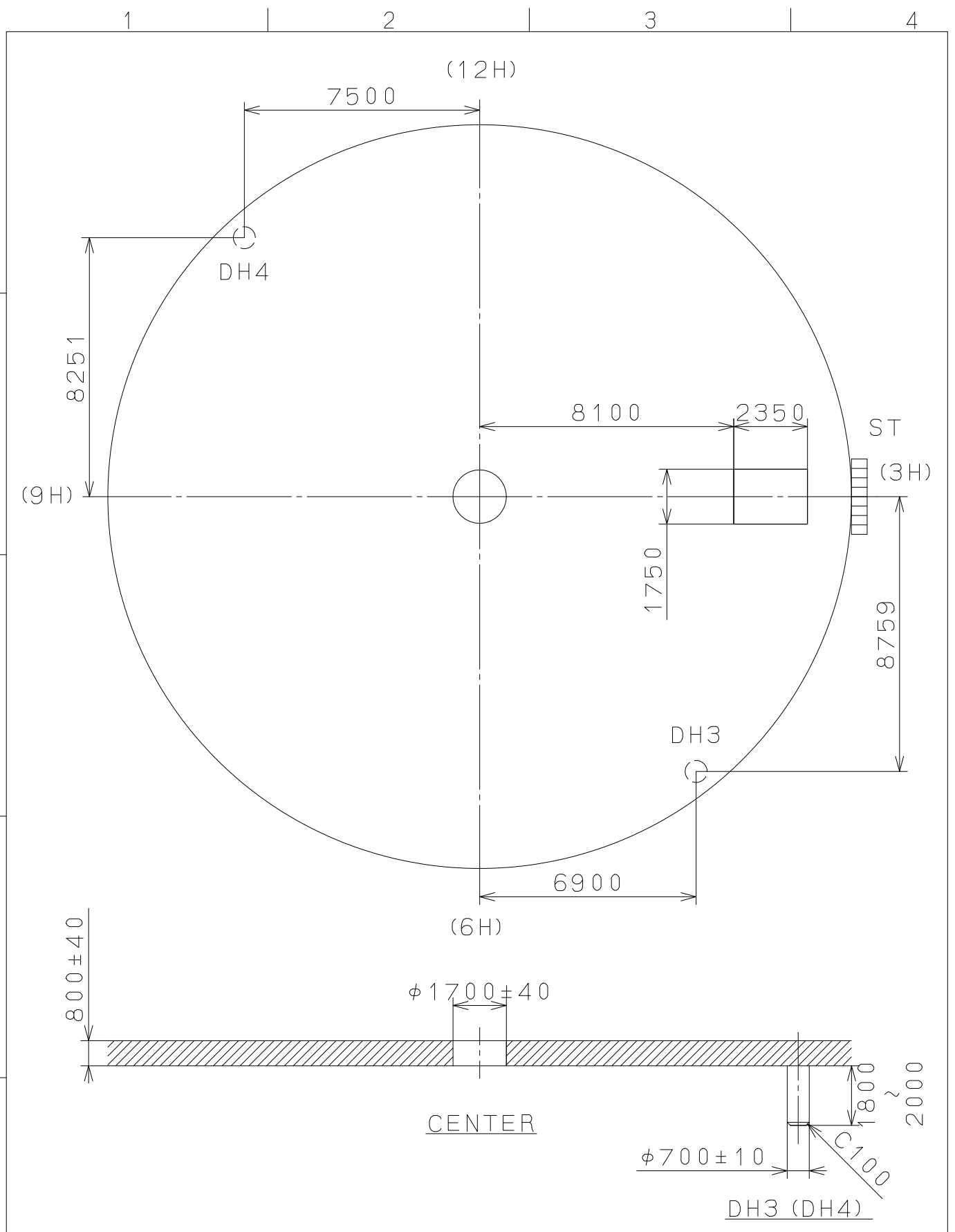

△			Quantity		Cal.NO.:
△			Unit	1/1000mm	2117-30A
△			Scale	6:1	Parts No.:
△			Date		
△			Drawn		
Mark	Date	Description	Appr.	Checked	Name:
		Alterations	Approved	D. Yamada	Indications for Dial
Material					Drawing No.: 211700D1
Heat Treatment			General Tolerances		MIYOTA
Hardness			Dimensions		
Plating			Angles		
					CITIZEN WATCH CO., LTD. TOKYO, JAPAN

This drawing is provisional and subject to our reconfirmation and/or revision without notice.

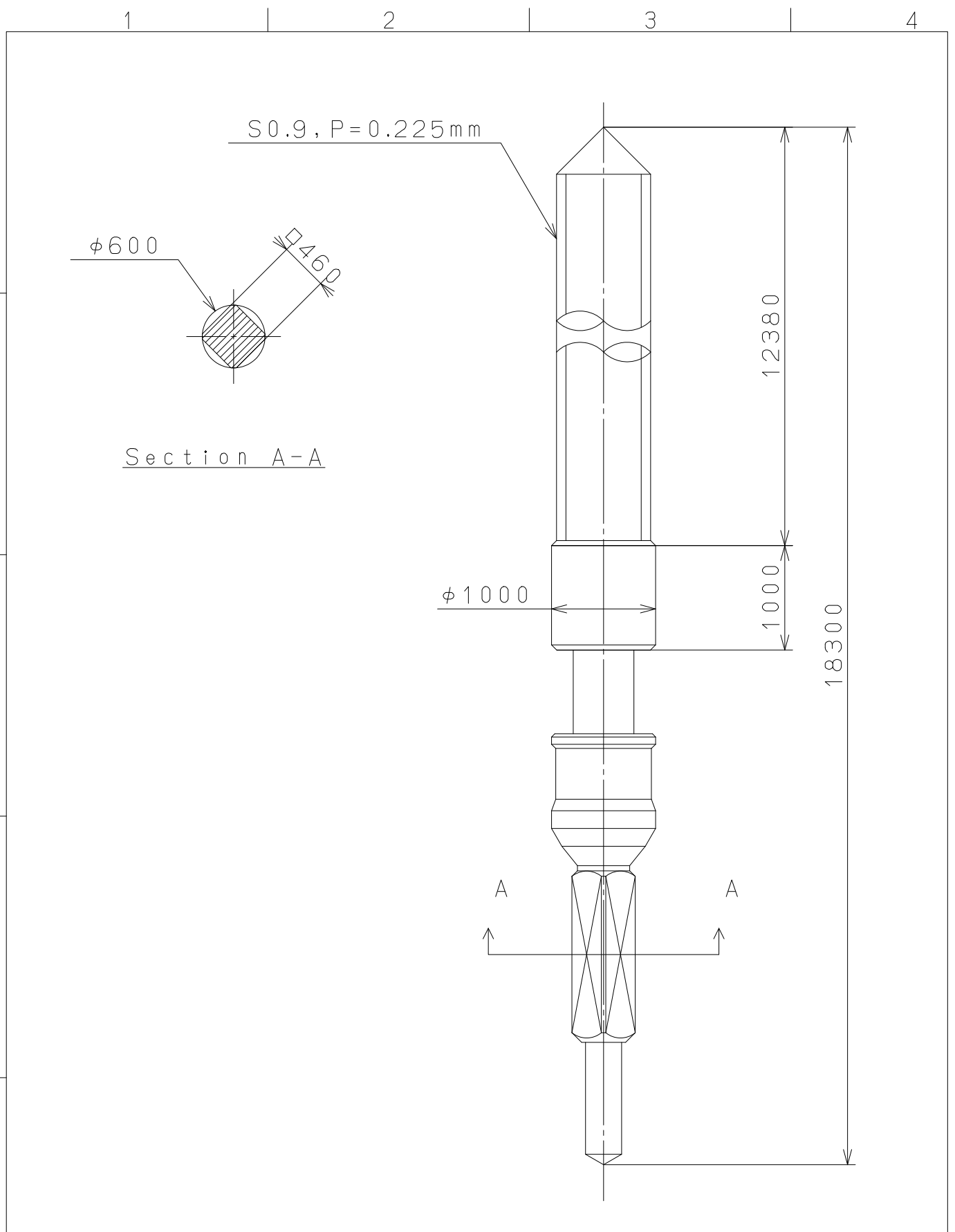

△5			Quantity		Cal.NO.:
△4			Unit	1 / 1000 mm	
△3			Scale	20 : 1	Parts No.:
△2			Date		065-299
△1			Drawn		
Mark	Date	Description	Appro.	Checked	D. Yamada
Alterations			Approved	Name:	
					SETTING STEM
Material					Drawing No.: 299000S0
Heat Treatment					MIYOTA CITIZEN WATCH CO., LTD. TOKYO, JAPAN
Hardness	General Tolerances				
Plating	Dimensions				
	Angles				