

This drawing is provisional and subject to our reconfirmation and/or revision without notice.

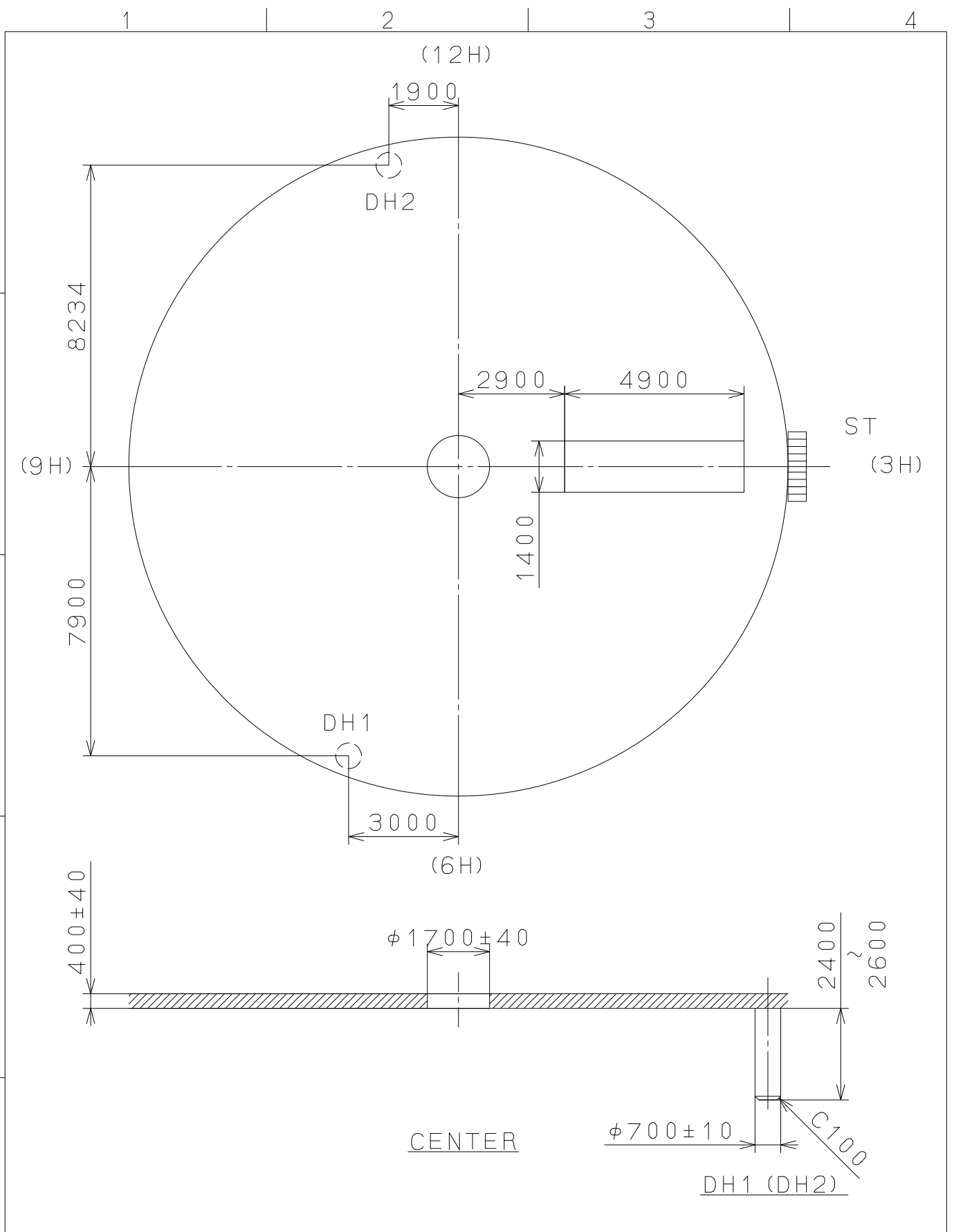

△			Quantity		Cal.NO.:
△			Unit	1 / 1000 mm	2005-3AN
△			Scale	7 : 1	Parts No.:
△			Date		
△			Drawn		
Mark	Date	Description	Appr.	Checked	Name:
		Alterations	Approved	D. Yamada	Indications for Dial
Material					Drawing No.: 200502D1
Heat Treatment			General Tolerances		<b>MIYOTA</b>
Hardness			Dimensions		
Plating			Angles		
					CITIZEN WATCH CO., LTD. TOKYO, JAPAN